



SERIES G2 PRODUCT DATA SHEET

MODEL	PART NUMBER	MOTOR TYPE
SG2 15-A-E12V-10DL-WR00-MC	104520	Electric 12V
SG2 15-C-E12V-10DL-WR00-MC	104525	Electric 12V
SERIAL NUMBER	INSPECTED BY	DATE

ENGINEERING DATA		
Rated Pulling Force:	15000 lbf	6804 kgf
Drum Barrel Diameter:	4 in	101.6 mm
Drum Flange Diameter:	8.24 in	209.3 mm
Drum Width:	9.95 in	252.7 mm
Evaluated Rope Diameter:	1/2 in	12.7 mm
Maximum Wire Rope Diameter:	1/2 in	12.7 mm
Minimum Wire Rope Breaking Strength:	26600 lbf	12065 kgf
Maximum Layers of Wire Rope:	3 with 1/2in rope	
Gear Train:	Planetary	
Gear Reduction:	321:1	
Mounting Bolt Size:	M12 X 1.75 Class 8.8	
Mounting Bolt Torque:	46-51 lbf-ft	63-69 Nm
Duty Cycle (per SAE J706 section 6.2):	12.4 ft	3.8 m
Approximate Shipping Weight:	99.4 lbf	45.1 kg
Brake Type:	Automatic Disk Brake per SAE J706 Sec. 4.2	
Sealing:	IP68/IP69K	
UV Rating:	1200 kJ/m ² per ASTM G154	
Corrosion Resistance:	408 hrs per ASTM B117	
Operating Temperature:	-40°F to 158°F (-40°C to 70°C)	
Decibels:	85.5 dB	
EMC Emissions:	CISPR 25:2008	
EMC Immunity:	ISO 7637-2:2004	

PERFORMANCE BY LAYER					
DRUM LAYER	LINE LOAD*			LINE SPEED	
	lbf	kgf	kN	ft/min	m/min
1	15000	6804	66.7	19.1	5.8
2	12273	5567	54.6	20.2	6.2
3	10385	4710	46.2	21.3	6.5

*Never exceed the Rated Pulling Force. Installation of a Rated Capacity Limiter is recommended

FIRST LAYER PERFORMANCE					
LINE LOAD		CURRENT DRAW	LINE SPEED (AT LOAD)		DUTY CYCLE
lbf	kgf	AMPS	ft/min	m/min	min/10min
0	0	103.4	19.1	5.8	2:30
3000	1361	217.2	10.3	3.1	1:50
6000	2722	310.7	7.7	2.3	1:20
9000	4082	401.9	6.7	2.0	1:00
12000	5443	495.2	5.4	1.6	0:50
15000	6804	579.7	4.8	1.5	0:30



DESCRIPTION

SeriesG2 Electric winches provide new levels of performance, durability, and efficiency to help get jobs done quickly and reliably time after time.

ACCESSORIES

SeriesG2 winches represents an all-new level of modular design, customization, and versatility, no matter the application. Please visit www.warn.com/industrial for all available accessories and options.

STANDARDS COMPLIANCE

2006/42/EC - EN ISO 12100:2010, EN 60529:1992+A2:2013, EN 14492-1:2006*
 2014/30/EU - EN 50498:2010, ISO 7637-2:2011, CISPR 25
 2011/65/EU - EN 63000:2018

Also complies with:
SAE J706

*Conforms with exceptions

DRUM ROTATION

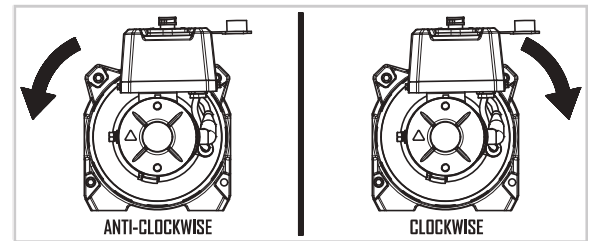

As viewed from motor end

FIRST LAYER PERFORMANCE

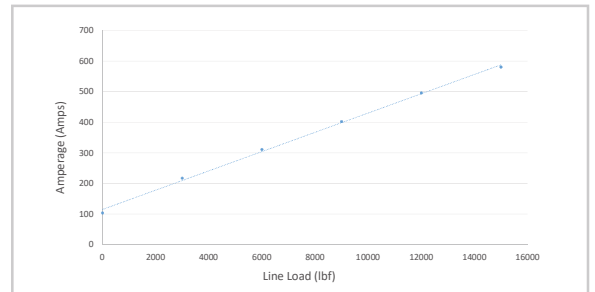



SERIES G2 PRODUCT DATA SHEET

MODEL	PART NUMBER	MOTOR TYPE
-------	-------------	------------

SG2 15-A-E12V-10DL-WR00-MC	104520	Electric 12V
SG2 15-C-E12V-10DL-WR00-MC	104525	Electric 12V

DRUM CAPACITY BY LAYER

DRUM LAYER	DRUM LENGTH							
	6.5"		8"		10"		12.5"	
	ft	m	ft	m	ft	m	ft	m
1	16	4.9	16	4.9	20	6.1	27	8.2
2	36	11.0	36	11.0	45	13.7	61	18.6
3	60	18.3	60	18.3	75	22.9	100	30.5

TOTAL DRUM CAPACITY

ROPE DIAMETER	DRUM LENGTH							
	6.5"		8"		10"		12.5"	
	ft	m	ft	m	ft	m	ft	m
1/2	60	18.3	60	18.3	75	22.9	100	30.5

ELECTRICAL SYSTEM SPECIFICATIONS

Battery Voltage:	12V
Minimum Battery Rating:	650 CCA
Maximum Rated Input Speed:	5204 RPM

WIRING SCHEMATIC

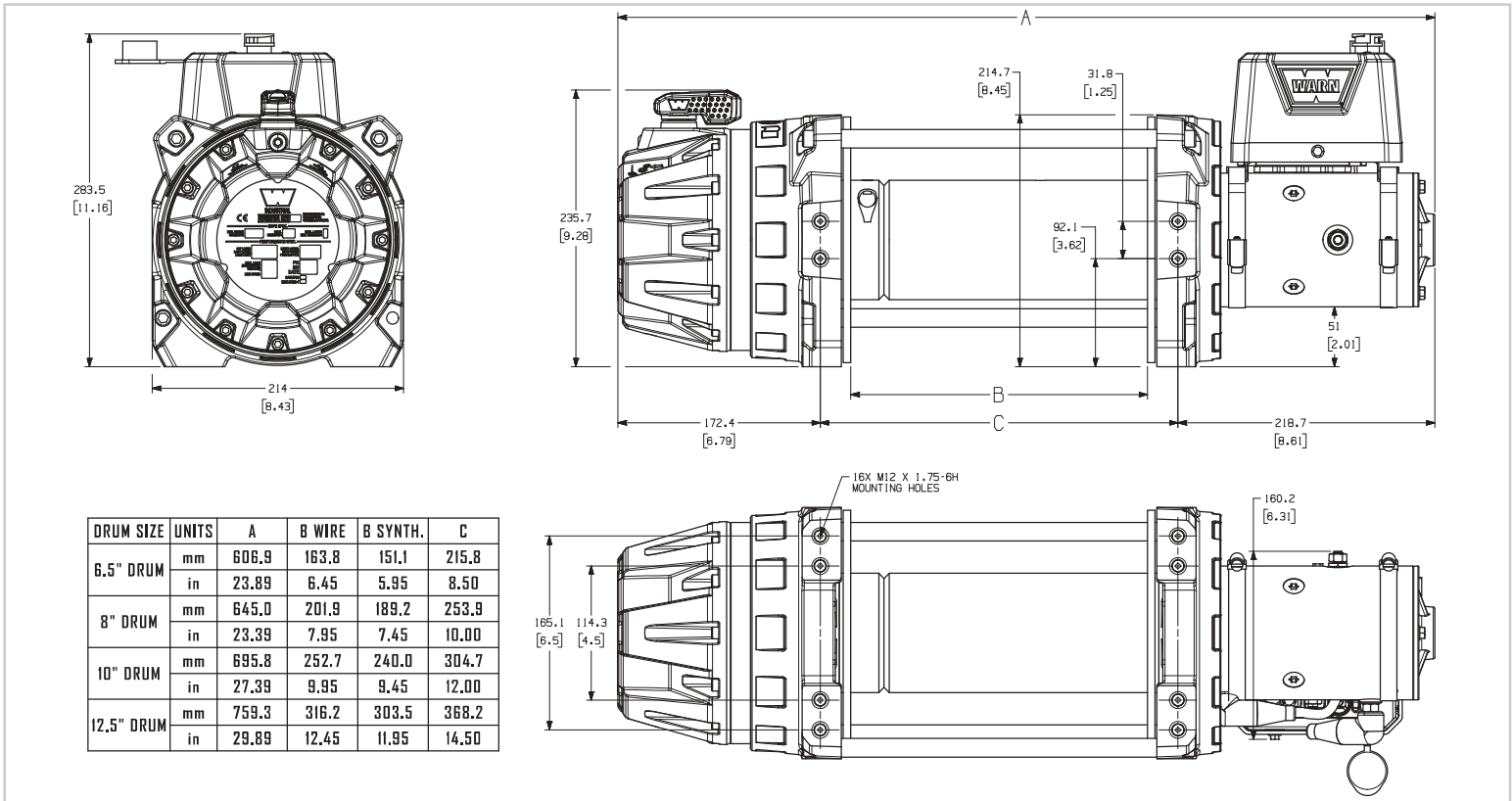
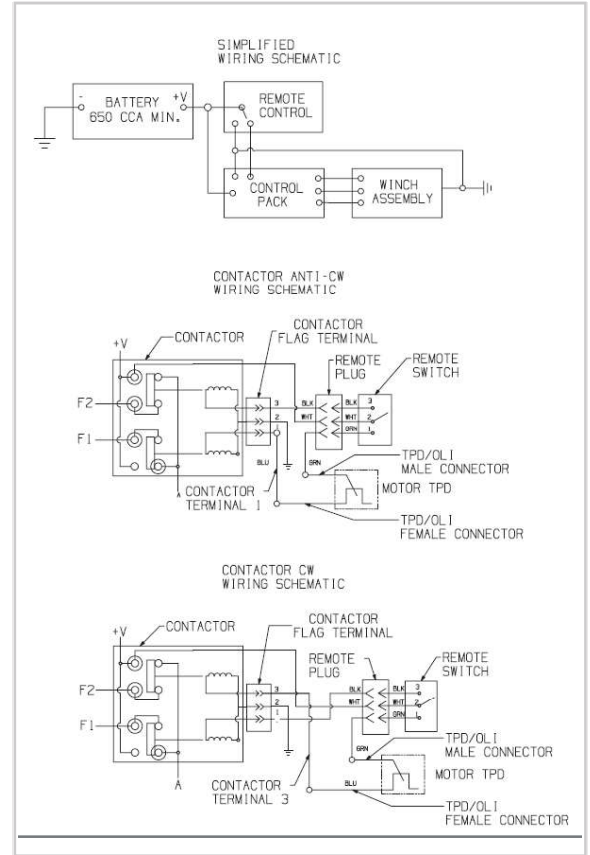



MOUNTING CONFIGURATIONS

MODEL	PART NUMBER	MOTOR TYPE
SG2 15-A-E12V-10DL-WR00-MC	104520	Electric 12V
SG2 15-C-E12V-10DL-WR00-MC	104525	Electric 12V

ALL MOUNTING MUST BE OBSERVED FROM MOTOR END

FEET DOWN, ROPE UNDER DRUM, COMING IN FROM THE LEFT (DUL) - ANTI-CLOCKWISE ROTATION

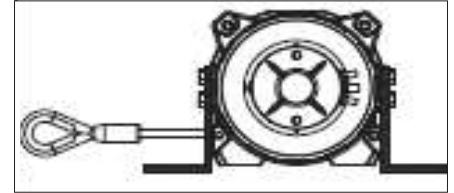
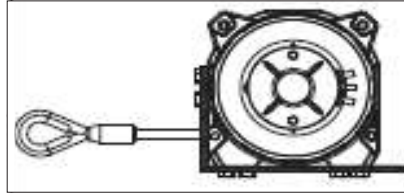
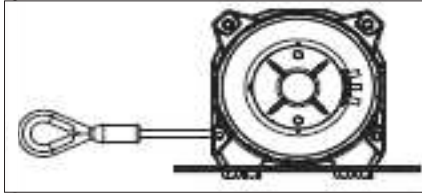

FEET DOWN, ROPE UNDER DRUM, COMING IN FROM THE RIGHT (DUR) - CLOCKWISE ROTATION

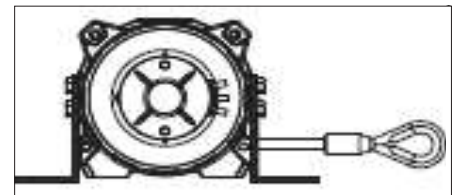
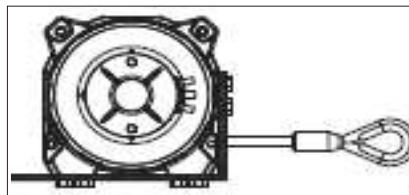
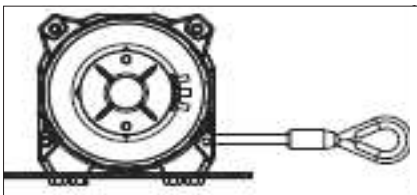

FEET DOWN, ROPE OVER DRUM, COMING IN FROM THE LEFT (DOL) - CLOCKWISE ROTATION

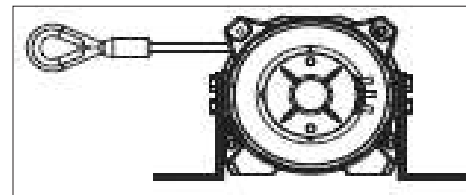
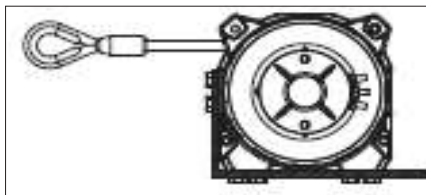

FEET DOWN, ROPE OVER DRUM, COMING IN FROM THE RIGHT (DDR) - ANTI-CLOCKWISE ROTATION

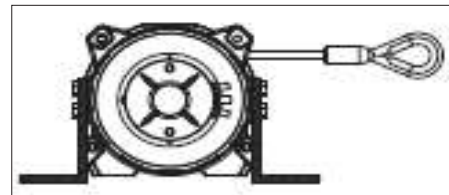
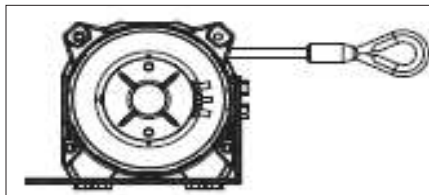

FEET FORWARD, ROPE OVER DRUM, COMING IN FROM THE LEFT (FOL) - CLOCKWISE

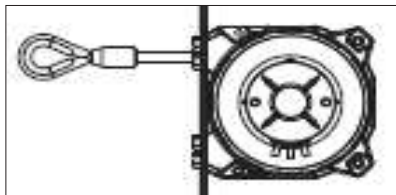

FEET FORWARD, ROPE UNDER DRUM, COMING IN FROM THE LEFT (FUL) - ANTI-CLOCKWISE

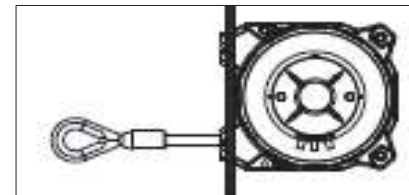

FEET FORWARD, ROPE OVER DRUM, COMING IN FROM THE RIGHT (FOR) - ANTI-CLOCKWISE

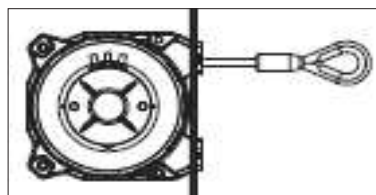

FEET FORWARD, ROPE UNDER DRUM, COMING IN FROM THE RIGHT (FUR) - ANTI-CLOCKWISE

